

Speed Controller with One-touch Fitting Elbow Type/Universal Type

Series AS

Minimizes installation time and cost

Reduces the mounting height and enables compact machinery design. Effective area is larger than the former model.

Tube swivels 360°

Universal type permits 360° piping swivel.

ø2 size added to applicable tubing sizes

- **Metric size** (Release button: White color)
ø2, ø3.2, ø4, ø6, ø8, ø10, ø12
- **Inch size** (Release button: Orange color)
ø1/8", ø5/32", ø3/16", ø1/4", ø5/16", ø3/8", ø1/2"

Maximum operating pressure 1 MPa max.

Applicable tubing materials

Nylon, soft nylon, and polyurethane tubing are applicable.

Retainer prevents accidental loss of needle.

Option

Hexagonal lock nut, Nickel plated option

Number of needle rotations has been increased (8 to 10 turns)

The increased number of needle rotations (8 to 10 turns) permits easy control at low speeds.

Model

Elbow type	Universal type	Port size	Applicable tubing O.D.														Applicable cylinder bore size (mm)			
			Metric size							Inch size										
			2	3.2	4	6	8	10	12	1/8"	5/32"	3/16"	1/4"	5/16"	3/8"	1/2"				
AS12□1F-M3	AS13□1F-M3	M3 x 0.5	● ⁽²⁾	●	●							●	●							2.5, 4, 6
AS12□1F-M5	AS13□1F-M5	M5 x 0.8	● ⁽²⁾	●	●	●						●	●	●	●					6, 10, 16, 20 ⁽¹⁾
AS12□1F-U10/32	AS13□1F-U10/32	10-32 UNF		●	●	●						●	●	●	●					6, 10, 16, 20
AS22□1F-01	AS23□1F-01	R 1/8		●	●	●	●	● ⁽²⁾				●	●	●	●					20, 25, 32
AS22□1F-02	AS23□1F-02	R 1/4			●	●	●	●				●	●	●	●	●				20, 25, 32, 40
AS32□1F-02	AS33□1F-02	R 1/4				●	●	●	●				●	●	●	●				40, 50, 63
AS32□1F-03	AS33□1F-03	R 3/8					●	●	●	●				●	●	●				40, 50, 63
AS42□1F-04	AS43□1F-04	R 1/2							●	●							●	●		63, 80, 100

- Note 1) AS12□1F-M5-02 applicable cylinder bore sizes are 2.5, 4, 6.
 Note 2) Elbow type only
 Note 3) Meter-out and meter-in types can be visually differentiated by the lock nut. The lock nut on the meter-out type is electroless nickel plated, while the meter-in type is black zinc chromate plated.
 Note 4) ● Marking is electroless nickel plated, provided as standard. (N specifications)

Specifications

Fluid	Air
Proof pressure	1.5 MPa (1.05 MPa ⁽¹⁾)
Max. operating pressure	1 MPa (0.7 MPa ⁽¹⁾)
Mini. operating pressure	0.1 MPa
Ambient and fluid temperature	-5 to 60°C (No freezing)
Number of needle rotations	10 turns (8 turns ⁽²⁾)
Applicable tubing material ⁽³⁾	Nylon, Soft nylon, Polyurethane ⁽⁴⁾
Option	With seal, Hexagon lock nut ⁽⁵⁾ , Electroless nickel plated ⁽⁶⁾

- Note 1) In case of AS12□1F-M3-02, AS12□1F-M5-02
 Note 2) In case of AS12□1F-M5 and AS12□1F-U10/32 types.
 In case of AS13□1F-M5 and AS13□1F-U10/32
 AS12□1F-M5-02: 10 turns.
 Note 3) Use caution regarding the max. operating pressure when soft nylon or polyurethane tubing is used. (Refer to pages 371 and 372 for details.)
 Note 4) In case of AS12□1F-M3-02 and AS12□1F-M5-02, polyurethane only.
 Note 5) M3, M5, 10-32UNF type ports are not available with seals.
 Note 6) Brass parts are all electroless nickel plated.

Flow Rate and Effective Area

Model	AS12□1F-M3 AS13□1F-M3 AS12□1F-M5-02	AS12□1F-M5 AS13□1F-M5	AS22□1F-01 AS23□1F-01	AS22□1F-02 AS23□1F-02	AS32□1F AS33□1F	AS42□1F AS43□1F							
	Tubing O.D.	Metric size ø2, ø3.2, ø4	ø3.2, ø4, ø6	ø3.2, ø4 ø6, ø8, ø10	ø4 ø6 ø8, ø10	ø6 ø8 ø10, ø12	ø10 ø12						
	Inch size ø1/8", ø5/32"	ø1/8", ø3/16" ø1/4", ø5/32"	ø1/8", ø3/16", ø1/4", ø5/32" ø5/16"	ø5/32" ø3/16" ø1/4", ø5/16", ø3/8"	ø1/4", ø5/16" ø3/8"	ø3/8" ø1/2"							
Controlled flow (Free flow)	Flow rate L/min (ANR)	20	100	180	230	260	390	460	660	790	920	1580	1710
	Effective area (mm ²)	0.3	1.5	2.7	3.5	4	6	7	10	12	14	24	26

- Note 1) Flow rate values are measured at 0.5 MPa and 20°C.
 Note 2) U10/32 has the same specification as M5.

Elbow type
Applicable tubing O.D. ø2



Universal type



JIS Symbol

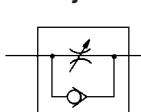

Flow Direction Symbols on Body

	Meter-out type	Meter-in type
Symbol		
JIS Symbol		

Caution

Be sure to read before handling.
 Refer to front matters 58 and 59 for Safety Instructions and pages 412 to 414 for Flow Control Equipment Precautions.

Made to Order
 (Refer to page 422 for details.)

How to Order

AS 2 2 0 1F - [] 01 - 06 S - []

Body size

1	M3, M5 standard
2	1/8, 1/4 standard
3	3/8 standard
4	1/2 standard

Type

2	Elbow
3	Universal

Control type

0	Meter-out
1	Meter-in

With One-touch fitting

Thread type

Nil	Metric thread (M3, M5)
	Unified thread (10-32 UNF)
N	R
	NPT

Made to Order
(Refer to page 422 for details.)

Option

Nil	None
S	With seal
K	Hexagonal lock nut
N	Electroless nickel plated

*1 If more than one option is required, write option part numbers in the order of "S", "K", "N".
*2 M3, M5, and U10/32 are not available with seals.

Applicable tubing O.D.

Metric size	Inch size
02	ø2
23	ø3.2 [*]
04	ø4
06	ø6
08	ø8
10	ø10
12	ø12
01	ø1/8"
03	ø5/32"
05	ø3/16"
07	ø1/4"
09	ø5/16"
11	ø3/8"
13	ø1/2"

*Use ø1/8" tube.

Port size

M3	M3 x 0.5
M5	M5 x 0.8
U10/32	10-32 UNF
01	1/8
02	1/4
03	3/8
04	1/2

Needle Valve/Flow Characteristics

**AS1201F-M3, AS1211F-M3
AS1301F-M3, AS1311F-M3
AS1201F-M5-02, AS1211F-M5-02**

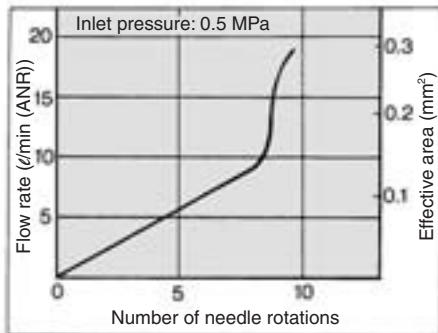

**AS1201F-M5, AS1211F-M5
AS1301F-M5, AS1311F-M5**

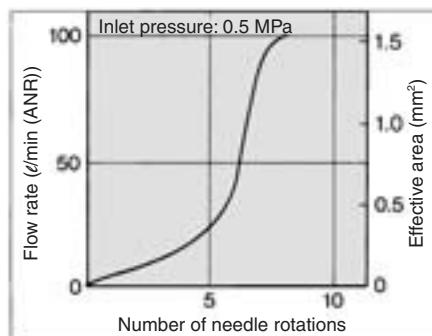

Note) "-U10/32" is the same as "M5".

**AS2201F-01, AS2211F-01
AS2301F-01, AS2311F-01**

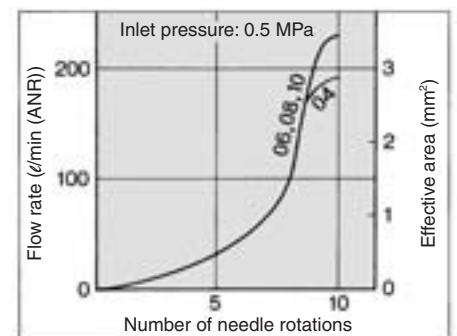

**AS2201F-02, AS2211F-02
AS2301F-02, AS2311F-02**

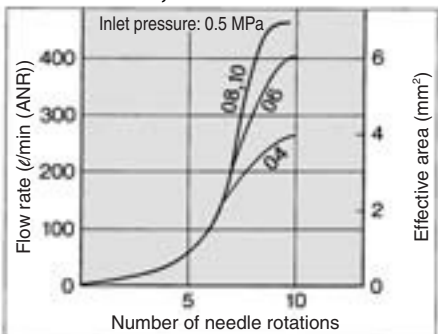

**AS3201F, AS3211F
AS3301F, AS3311F**

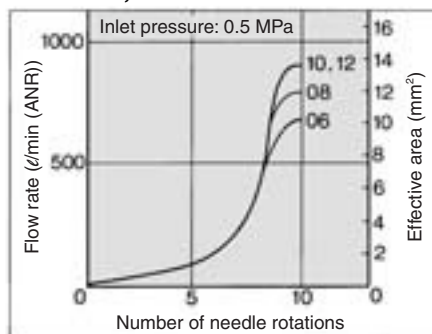

**AS4201F, AS4211F
AS4301F, AS4311F**

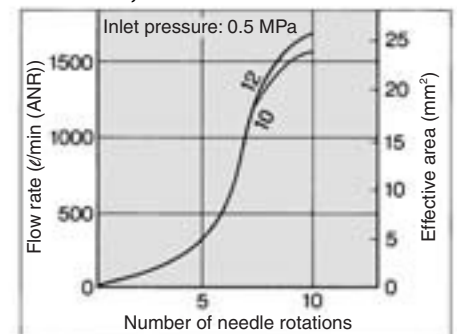

- AS
- ASP
- ASN
- AQ
- ASV
- AK
- VCHC
- ASS
- ASR
ASQ
- KE
- TMH

Speed Controller with One-touch Fitting Elbow Type/Universal Type *Series AS*



Universal Type

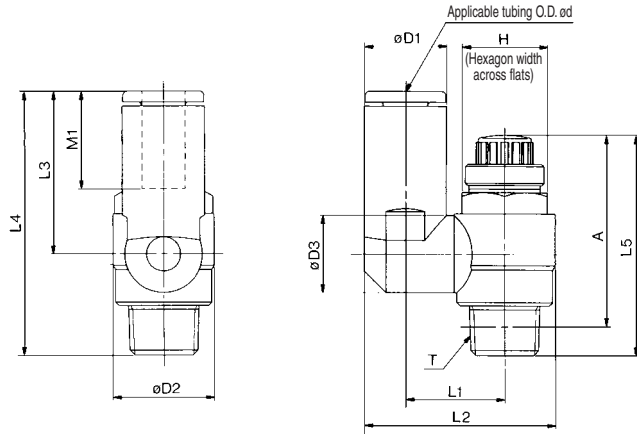

M3 port
M5 port
U10/32 port

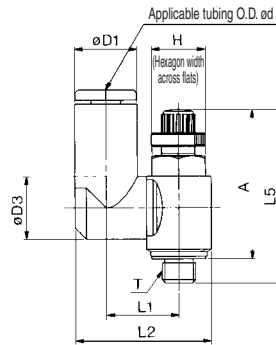
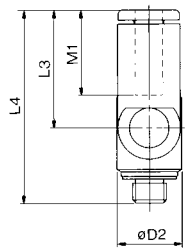

Metric Size

Model	Applicable tubing O.D. ød	T	H ⁽¹⁾	D1	D2	D3	L1	L2	L3	L4	L5 ⁽³⁾		A ⁽²⁾		M1	Mass (g)
											Max.	Min.	Max.	Min.		
AS13□1F-M3-23	3.2	M3 x 0.5	5.5	8.4	7.2	7.2	10.1	17.9	17.6	28.3	26.6	24.1	24	21.5	12.7	4
AS13□1F-M3-04	4			9.3				18.3	17.9	28.6						
AS13□1F-M5-23	3.2	M5 x 0.8	8	8.4	9.6	9.3	10.8	19.8	17.5	28.7	28.6	25.8	25	22.2	12.7	7
AS13□1F-U10/32-23																
AS13□1F-M5-04	4	M5 x 0.8	8	9.3	9.6	9.3	10.8	20.3	17.5	28.7	28.6	25.8	25	22.2	12.7	7
AS13□1F-U10/32-04	10-32UNF															
AS13□1F-M5-06	6	M5 x 0.8	8	11.6	9.6	9.3	10.8	21.4	20.6	31.8	28.6	25.8	25	22.2	13.5	10
AS13□1F-U10/32-06	10-32UNF															
AS23□1F-01-23	3.2	1/8	12 (12.7)	8.4	14.2	9.3	13.1	24.4	17.5	30.9	35.2	30.2	32.1	27.1	12.7	17
AS23□1F-01-04	4			9.3				13.1								
AS23□1F-01-06	6	11.6	10.9	14	26.9	22.9	36.3	39.9	34.9	34.4	29.4	32.1	27.1	13.5	18	
AS23□1F-01-08	8	15.2	12.9	16.2	30.9	28.2	40.8									
AS23□1F-02-04	4	1/4	17 (17.5)	10.4	18.5	10.9	16.2	30.6	21.9	39.6	39.9	34.9	34.4	29.4	16	32
AS23□1F-02-06	6			12.8				12.9								
AS23□1F-02-08	8	15.2	12.9	18.3	35.2	28.2	45.1	48.3	43.3	42.8	37.8	34.4	29.4	17	33	
AS23□1F-02-10	10	18.5	20.2	38.7	31	47.9										
AS33□1F-02-06	6	1/4	17 (17.5)	12.8	18.5	12.9	20.6	38.5	25.2	46.5	48.3	43.3	42.8	37.8	17	60
AS33□1F-02-08	8			15.2				12.9								
AS33□1F-02-10	10	18.5	23	23	43.7	32.6	53.9	45.4	40.4	40	35	34.4	29.4	21	67	
AS33□1F-02-12	12	20.9	23	44.9	34.4	55.7										
AS33□1F-03-06	6	3/8	19	12.8	16.2	12.9	20.6	38.5	25.2	45	45.4	40.4	40	35	17	56
AS33□1F-03-08	8			15.2				12.9								
AS33□1F-03-10	10	18.5	23	23	43.7	32.6	52.4	45.4	40.4	40	35	34.4	29.4	21	63	
AS33□1F-03-12	12	20.9	23	44.9	34.4	54.2										
AS43□1F-04-10	10	1/2	24 (23.8)	18.5	28.6	16.2	25.8	49.4	32.6	57.1	56.7	49.2	49.6	42.1	21	104
AS43□1F-04-12	12			21.7				19.4								

Note 1) () are the dimensions of NPT thread
 Note 2) Reference thread dimensions after installation.
 Note 3) Reference dimensions

Inch Size

Model	Applicable tubing O.D. ød	T	H ⁽¹⁾	D1	D2	D3	L1	L2	L3	L4	L5 ⁽³⁾		A ⁽²⁾		M1	Mass (g)
											Max.	Min.	Max.	Min.		
AS13□1F-M3-01	1/8"	M3 x 0.5	5.5	8.4	7.2	7.2	10.1	17.9	17.6	28.3	26.6	24.1	24	21.5	12.7	4
AS13□1F-M3-03	5/32"			9.3				18.3	17.9	28.6						
AS13□1F-M5-01	1/8"	M5 x 0.8	8	8.4	9.6	9.3	10.8	19.8	17.5	28.7	28.6	25.8	25	22.2	12.7	7
AS13□1F-U10/32-01	1/8"			10-32UNF												
AS13□1F-M5-03	5/32"	M5 x 0.8	8	9.3	9.6	9.3	10.8	20.3	17.5	28.7	28.6	25.8	25	22.2	12.7	7
AS13□1F-U10/32-03	5/32"	10-32UNF														
AS13□1F-M5-05	3/16"	M5 x 0.8	8	11.4	9.6	9.3	10.8	21.3	23.3	34.5	28.6	25.8	25	22.2	16.5	10
AS13□1F-U10/32-05	3/16"			10-32UNF												
AS13□1F-M5-07	1/4"	M5 x 0.8	12	11.6	12	9.3	10.8	21.6	20.7	31.9	28.6	25.8	25	22.2	13.7	8
AS13□1F-U10/32-07	1/4"			10-32UNF												
AS23□1F-01-01	1/8"	1/8	12 (12.7)	8.4	14.2	9.3	13.1	24.4	17.5	30.9	35.2	30.2	32.1	27.1	12.7	17
AS23□1F-01-03	5/32"			9.3				13.1								
AS23□1F-01-05	3/16"	1/8	12 (12.7)	11.6	14.2	10.9	14	28.8	23.9	37.3	35.2	30.2	32.1	27.1	16.5	21
AS23□1F-01-07	1/4"			13.2				12.9								
AS23□1F-01-09	5/16"	1/4	17 (17.5)	15.2	12.9	16.2	30.9	28.2	40.8	48.3	39.9	34.9	34.4	29.4	18.5	21
AS23□1F-02-03	5/32"			10.9				16.2								
AS23□1F-02-05	3/16"	1/4	17 (17.5)	11.6	18.5	10.9	16.2	31.1	23.9	42.1	48.3	43.3	42.8	37.8	16.5	33
AS23□1F-02-07	1/4"			13.2				18.5								
AS23□1F-02-09	5/16"	1/4	17 (17.5)	15.2	12.9	18.3	35.2	28.2	47.9	48.3	39.9	34.9	34.4	29.4	18.5	39
AS23□1F-02-11	3/8"			18.5				20.2								
AS33□1F-02-07	1/4"	1/4	19	13.2	12.9	20.6	38.7	25.6	46.9	48.3	43.3	42.8	37.8	17	60	
AS33□1F-02-09	5/16"			15.2				23								12.9
AS33□1F-02-11	3/8"	1/4	19	18.5	12.9	20.6	38.7	25.6	45.4	48.3	43.3	42.8	37.8	18.5	59	
AS33□1F-03-07	1/4"			13.2				23								12.9
AS33□1F-03-09	5/16"	3/8	24 (23.8)	15.2	16.2	25.8	49.4	32.6	57.1	56.7	49.2	49.6	42.1	21	104	
AS33□1F-03-11	3/8"			18.5				16.2								23
AS43□1F-04-11	3/8"	1/2	24 (23.8)	18.5	28.6	16.2	25.8	49.4	32.6	57.1	56.7	49.2	49.6	42.1	21	104
AS43□1F-04-13	1/2"			21.7				19.4								

Note 1) () are the dimensions of NPT thread
 Note 2) Reference thread dimensions after installation.
 Note 3) Reference dimensions

- AS
- ASP
- ASN
- AQ
- ASV
- AK
- VCHC
- ASS
- ASR
- ASQ
- KE
- TMH